

KÖSTER
Waterproofing Systems

**INSTALLATION
INSTRUCTIONS
KÖSTER TPO**



Contents

Basics

Products	4
KÖSTER TPO Characteristics	5
Mechanical fastening	7
Full surface adhesion	8
Loose installation	9
Tools	10
Welding temperature	11
Installation without separating layers	12

Installation

Good to know	13
Substrate conditions	14
Rolling out the membranes	15
Installation of mechanical fasteners	16
Overlapping	17
Fastening Plan	18
Loose laying	19
Full surface adhesion installation	20
Installation with polyurethane adhesive	22
Installation onto old membranes	24

Seam connection

Welding the overlaps	25
Manual welding	26
Automatic welding machine	29
Test welds	30

Connections

Membrane end connections	31
T connections	32
Connections to TPO coated sheet metal	33
Cross joints	34

Contents

Connections and terminations

Connections and terminations	35
Fastening edges	36
Wall connections	37
Parapet connections < 50 cm	38
Parapet connections >50 cm in one piece	39
Parapet connections >50 cm in two pieces	40
Tensioned connection	42
Roof penetrations	43
Connection to skylight	45
Joints	47
Roof ridge installation	48
Connection to rain gutter	49
Roof drainage	51

Inside and outside corners

Inside and outside corners	52
Pre-formed corners	53
Manually prepared outside corners	54
Manually prepared inside corners	55

Separating layer

57

Subject index

58

The information contained in these installation instructions are not binding and does not release the user from using the products to meet the requirements of the respective structure, application, and local building codes. In each case the applicable standards, leaflets, regulations, and generally accepted rules of good practice and the specifications in our technical data sheets must be adhered to.

Products

Products for individual requirements and fields of application.

Products			
	KÖSTER TPO <i>with centered glass fiber reinforcement</i>	KÖSTER TPO F (Fleece) ¹⁾ <i>with centered glass fiber reinforcement and laminated polyester fleece on the bottom.</i>	KÖSTER TPO U <i>homogenous material without glass fiber reinforcement</i>
Thickness (mm)	1.6/1.8/2.0	1.6/1.8/2.0 + 1.0 mm Fleece	2.0
Width (m)	2.10/1.50/1.05/ 0.75/0.525/ 0.35/0.25	2.10/1.05/0.525	1.05/0.525
Roll length	20 m	20 m	20 m
Colors	Light Grey ²⁾	Light Grey ²⁾	Light Grey ²⁾
Loose laying	●	●	For the fabrication of gutter and ventilator flanges, and for strengthening the corners during mechanical fastening.
Mechanical fastening	●	●	
Strip adhesion	-	●	
Full area adhesion	-	●	

1) Without polyester fleece on one or both sides of the membrane, (40 mm).

2) Further colors available on request.

KÖSTER TPO Characteristics

CE-Certification

according to the DIN EN 13956 (waterproofing membranes for roof waterproofing) and the DIN EN 13967 (waterproofing membranes for structural waterproofing)

Quality

assurance according to ISO 9001:2008 certified

Resistant

to flying sparks and radiated heat for approved roof superstructures

Resistant to hail impact

Resistant to ozone and radon

PVC Free

Norms, Industrial codes, testing

German roofing trade rules for waterproofing / Flat Roof Guidelines

Standards and general rules

DIN 18531

Norm for roof waterproofing

DIN 18338

Roof waterproofing work (VOB)

DIN 4102

Flammability

Mechanical fastening

Mechanical fastening is appropriate for all roofs, e.g. flat roofs, pitched roofs, green roofs, etc.

■ KÖSTER TPO-Roofing Membrane 1) Insulation 2) Supporting Construction

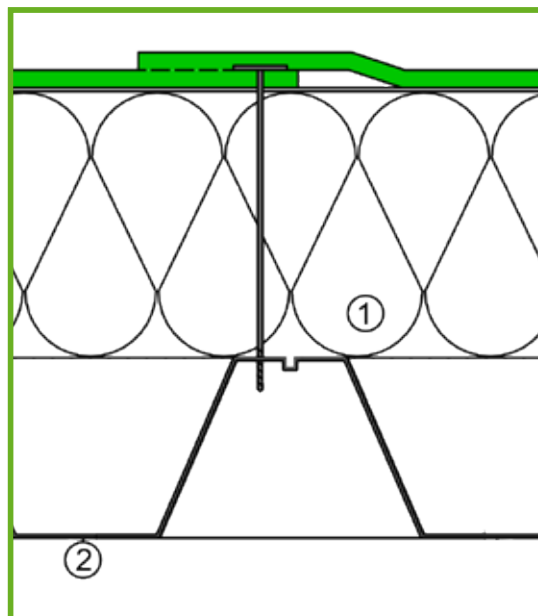

Full surface adhesion

Appropriate for roofs where the substructure may not be penetrated and where no ballast is anticipated.

■ KÖSTER TPO-Roofing Membrane 1) Insulation; 2) Sheathing; 3) Adhesive

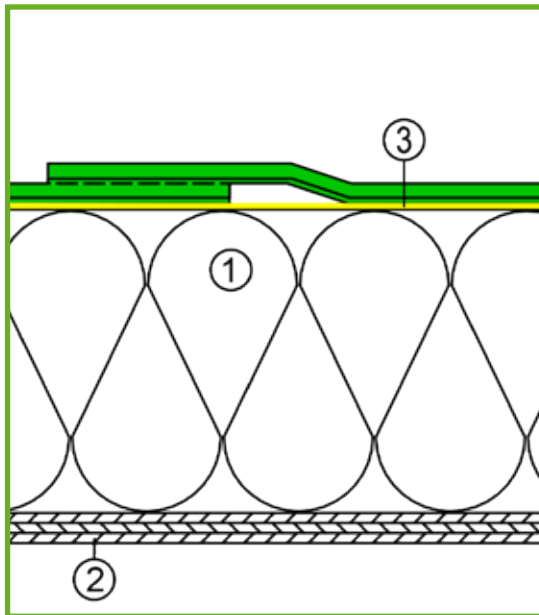

Loose installation

Appropriate for flat roofs with ballast (green roof or stone ballast)

■ KÖSTER TPO-Membrane 1) Insulation; 2) Sheathing; 4)+5) Ballast (green roof or stone ballast)

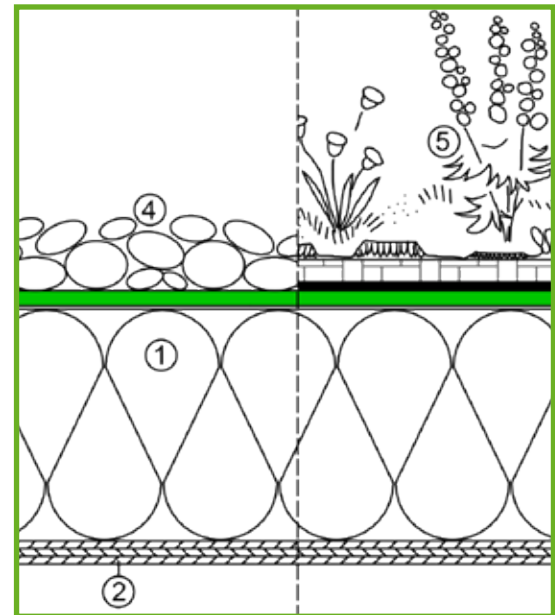

Tools

The standard equipment includes (1) a hand held hot air welder with (2) a wide slit nozzle, (3) scissors, (4) a silicone roller, (5) a thermometer, (6) a weld tester, (7) a wire brush, (8) a measuring tape or folding rule, and for larger roof areas an automatic welding machine.



Welding temperature

The welding temperature will vary according to weather and material thickness, the temperature of the exiting air should be between + 350 °C and + 620 °C. This should be readable on the display or tested and verified with a separate thermometer. Always conduct welding tests before beginning work.

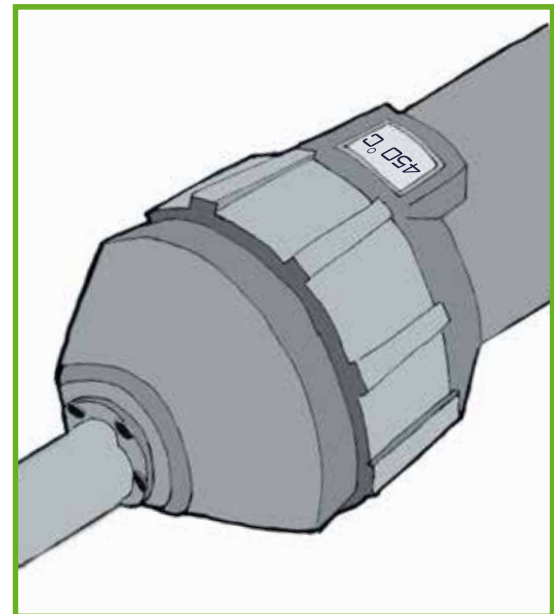

Installation without separating layers

KÖSTER TPO is free of plasticizers and generally can be applied on top of the insulation or old bituminous membranes without a separating layer. A fire protection layer can be specified, for this a glass matting is applicable.

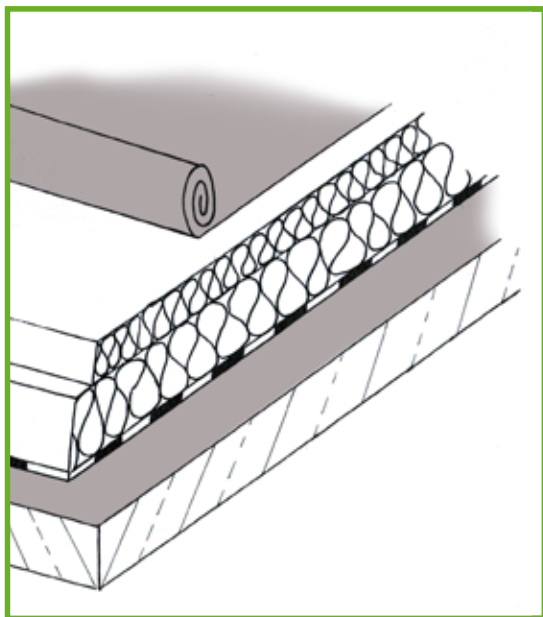

Good to know

KÖSTER TPO

are hot air welded into a homogenous material.

Mechanical fastening

amount and spacing are calculated according to the Flat Roof Guidelines.

The amount of mechanical fasteners

are written into a fastening plan and can be provided by KÖSTER.

> 4 pc./lm

amount of mechanical fasteners used when affixing metal bands, flashing, TPO coated metal.

10 mm

distance between mechanical fastener and membrane edge.

Substrate conditions

Testing the substrate

Noticeable defects in the surface must be repaired before installation.

Supporting construction

must meet the requirements for strength, deflection, anchoring, and water run-off.

Dilation joints

are to be honored depending on the roof design.

A minimum of 2 %

slope is to be assured, for example through tapered insulation.

Drainage

is to be situated at the lowest point of the roof.

Rolling out the membranes

Every membrane has markings printed onto it to ease positioning and orientation of the membrane. The width of the overlap depends on the type of installation. When mechanically fixating the membrane the overlap is 11 cm, when loose laying membranes and full surface adhesion the overlap is 5 cm.

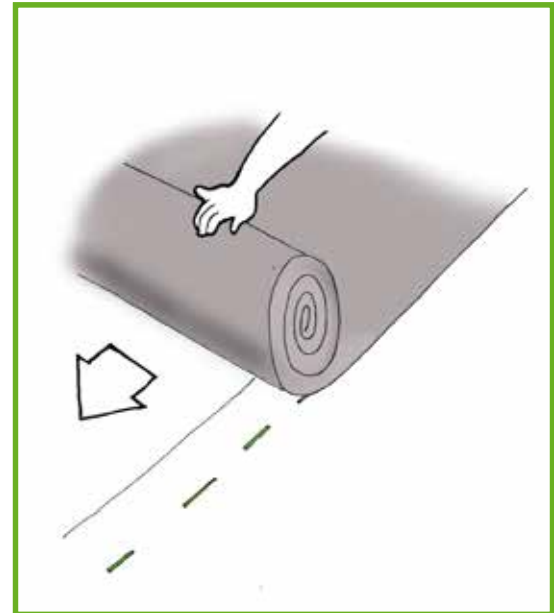

Installation of mechanical fasteners

When mechanically fastening the membranes they are attached to the substrate with pan headed screws or anchors. When installing over sloped insulation fasteners in various lengths must be at hand.

The quantity and spacing of the anchors is given in the Fastening Plan.

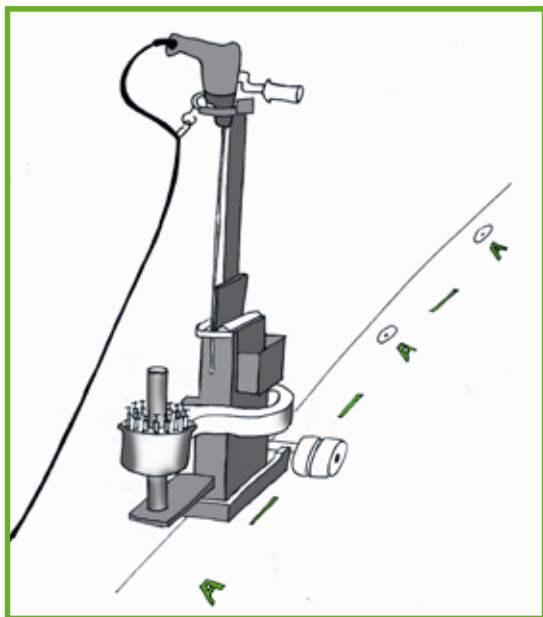

Overlapping

The membranes are usually asymmetrically attached, one side of the membrane serves as an overlap and the other one is mechanically fastened. When symmetrically attaching the membranes both sides of the membrane are fastened. The overlap should be 11 cm when mechanically fastening the membranes.

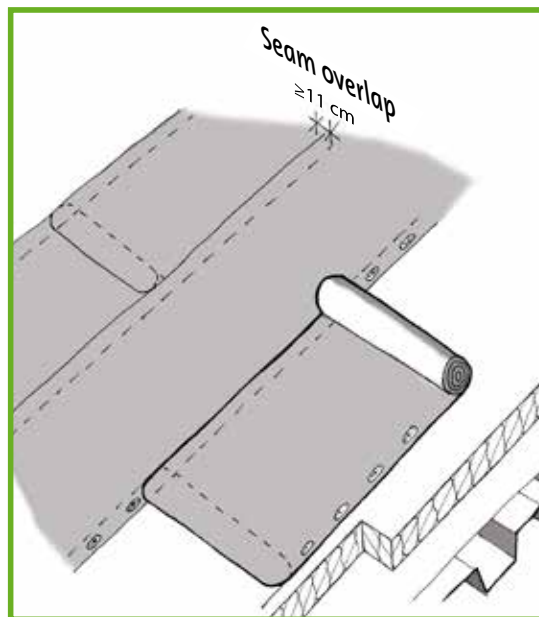

Full surface adhesion installation

Overlap

Generally 5 cm

The area of the welded seams

must be free of bitumen or other residues.

Full surface adhesion

When loose laying and mechanical fastening are uneconomical.

Adhesive

Hot bitumen or polyurethane adhesive can be used, (adhere to the manufacturer's instructions).

Adhesive consumption

Adhesive consumption is according to the Technical Data Sheets of the respective manufacturer.

Full surface adhesion installation

Laminated fleece backing

Only use KÖSTER TPO F Membranes with a laminated fleece backing. The fleece must always be dry during installation.

Repair

A full surface adhesion installation can only be done when the old roof construction is stable and solidly adhered or fastened. It is not allowed to post-adhere an old roof construction.

Installation with polyurethane adhesive

Adhesive

Manufacturer's instructions must be followed. The adhesive consumption must be measured according to the manufacturer's instructions.

In Strips

Apply the adhesive in strips, parallel to the membrane edge. Avoid weaving or serpentine application.

Rolling out and pressing down the membrane

KÖSTER TPO F (Fleece) is rolled out onto the adhesive and firmly pressed down. The area prepared with adhesive may only be as large as can be applied to within the reaction time of the adhesive.

Installation with polyurethane adhesive

Pressing down

the membranes is necessary to prevent the adhesive stripes from showing. This is accomplished with a roller or a suitable weight.

Colored roofing membranes

can discolor along the edges when installed with membrane adhesives. This however does not affect the function or durability of the membrane.

Initial bond strength

of adhesives is low. The TPO Membranes must be pressed down to activate the adhesion.

Polyurethane adhesive

must have low solvent contents and be approved for use with roof membranes.

Installation onto old membranes

Old and weathered membranes can serve as a substrate for new TPO Membranes. Patina and contaminants are easily removed with an angle grinder. When welding older TPO Membranes make a test weld to see if a pre-treatment is required.



A calendering tool is suggested for cleaning the substrate.

Welding the overlaps

Welding temperature

+ 350 °C to + 620 °C, depending on the surrounding conditions.

Professional hot air welding

guarantees a homogenous weld.

Test welds

are always to be performed before work begins.

5 cm

is the minimum overlap when welding manually or with an automatic welding machine.

Overlap welds against the water flow

Are allowed at connections, terminations, as well as when installing accessories.

Manual welding

When manually welding the membranes, the top layer is first spot welded. The hot air pistol is held in one hand and with the other the membrane is pressed down and affixed. This creates an air pocket, which traps hot air during final welding maintaining a constant and correct air temperature.

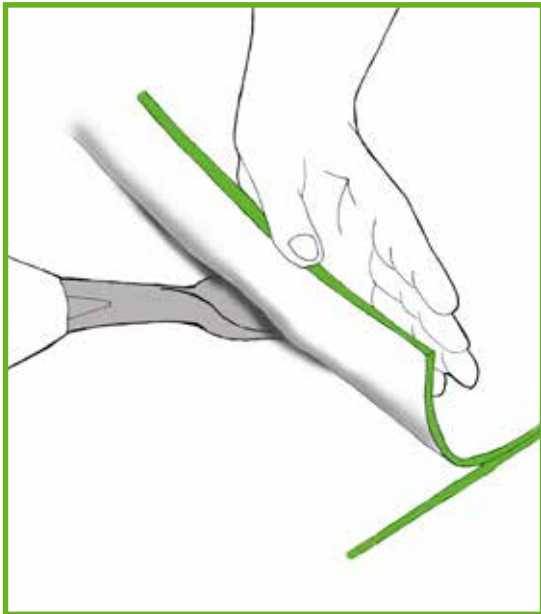

Manual welding

After the initial spot welding, the hot air pistol is uniformly pulled through the overlap. A silicone roller is used to press the membranes evenly together. Do not press the membranes together too firmly. A slight bead of TPO material exiting the weld serves as an optical quality control. The bead should have a diameter of approximately 1 mm.

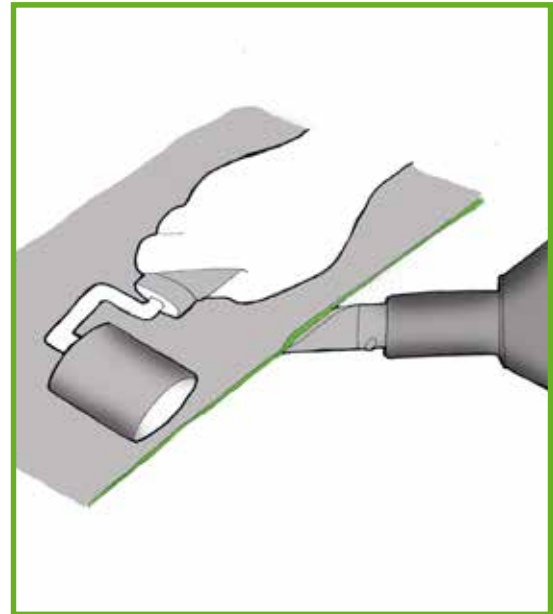

Manual welding

During manual welding make sure that the silicone roller is held parallel to the seam edge and a uniform pressure is applied. Avoid too much material exiting the seam.

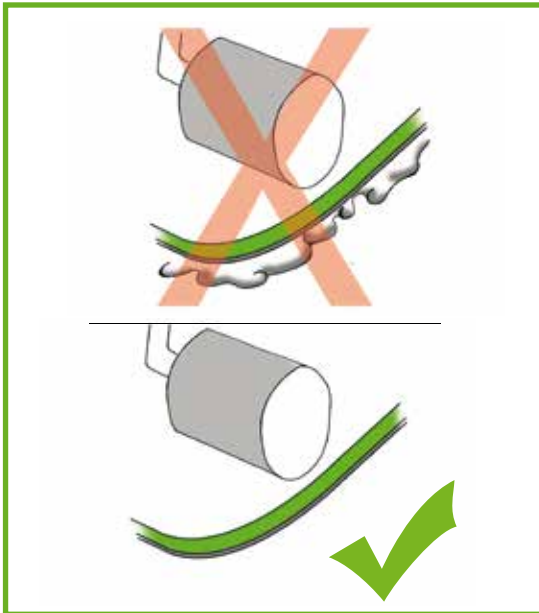

Automatic welding machine

When installing larger areas, an automatic welding machine is recommended. These machines combine spot- and final seam welding into one work step, and the advancement drive speed can be regulated. It is suggested to use a mobile power generator at cable lengths greater than 50 m with 230 V or greater than 100m at 400 V to prevent power loss.

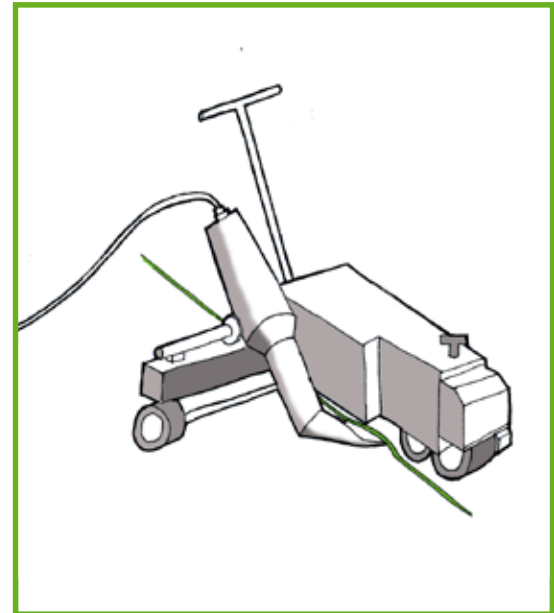

Test welds

Test welds are performed on site to determine the proper temperature and speed settings. During changing conditions this may have to be adjusted during work. The welds are tested at earliest 24 hours after completion and can be tested with a test needle or through a peel test. Membrane testing temperature must be $< + 20\text{ }^{\circ}\text{C}$.

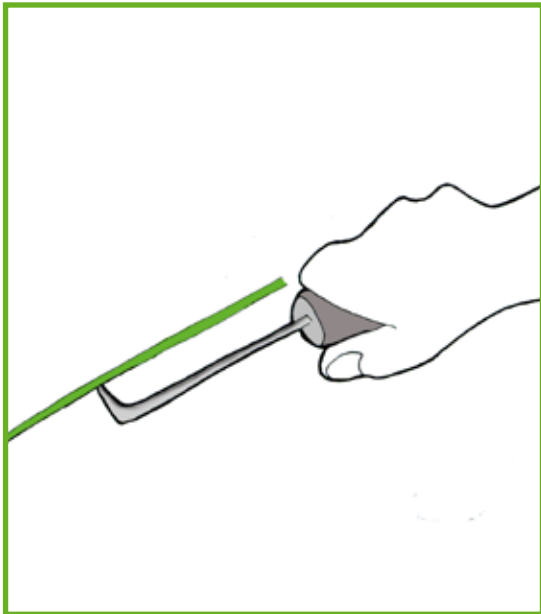

Membrane end connections

Membrane end connections are accomplished just as the membrane side connections. To insure a flawless installation all corners (such as at the membrane ends) are rounded off with scissors. This step applies to both the lower and upper membrane.

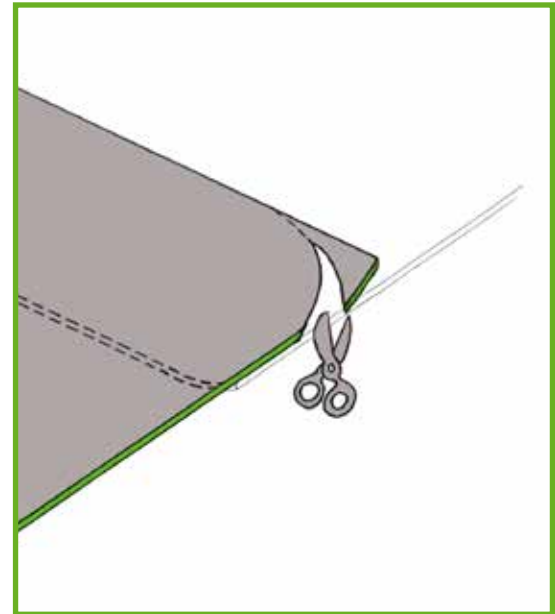

T connections

T connections must be homogenously welded to avoid capillary active defects. Rounding off the membrane corners in the areas of T connections greatly reduces the risk of installation flaws.

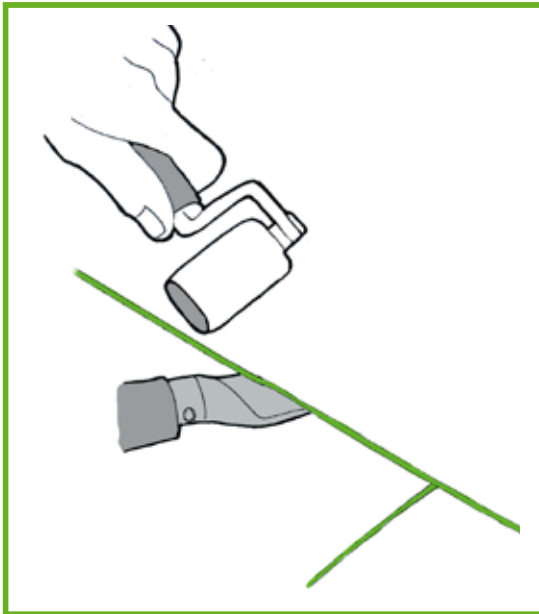

Connections to TPO coated sheet metal

TPO coated metal is used, for example, at wall connections and for drip edges. The TPO Membrane can be welded directly to the metal. Areas where the laminated metal sheets butt together are waterproofed with TPO pieces.

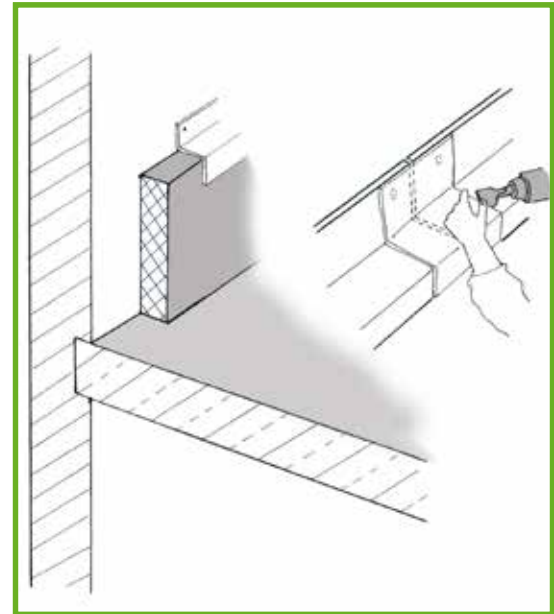

Cross joints

Cross joints are vulnerable to failure and should be absolutely avoided. It is better to stagger the overlaps or to attach a cover strip to avoid a crossed joint. If a crossed joint is unavoidable all four T corners are to be covered with a round patch with a minimum diameter of 20 cm.

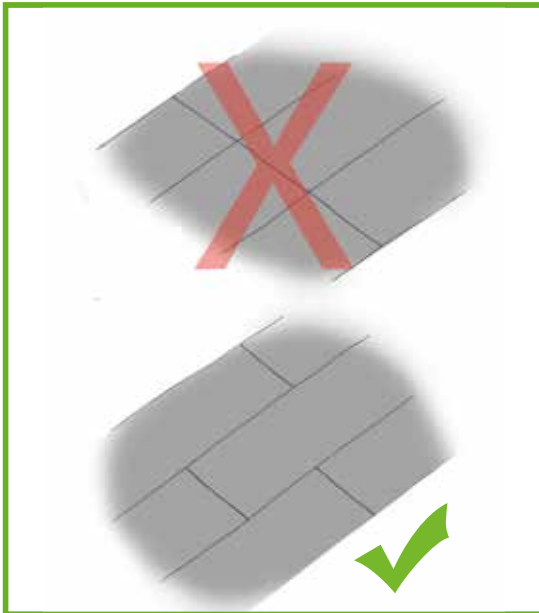

Connections and terminations

Horizontal forces

must be absorbed according to the Flat Roof Guidelines.

Every 25 cm

Flashings and TPO laminated metal must be mechanically fastened every 25 cm.

Windproof

All connections and terminations must be windproof.

Protection against water ingress

No water may seep behind connections and terminations.

Fillet areas and Valleys

Must be mechanically fastened every 25 cm, starting at an angle of 3° from horizontal.

Fastening edges

Angle profiles and flashing are used to form corner areas free of voids. For fastening the flashing special self-sealing screws such as Spengler screws are used.

Optionally single fasteners can be used.

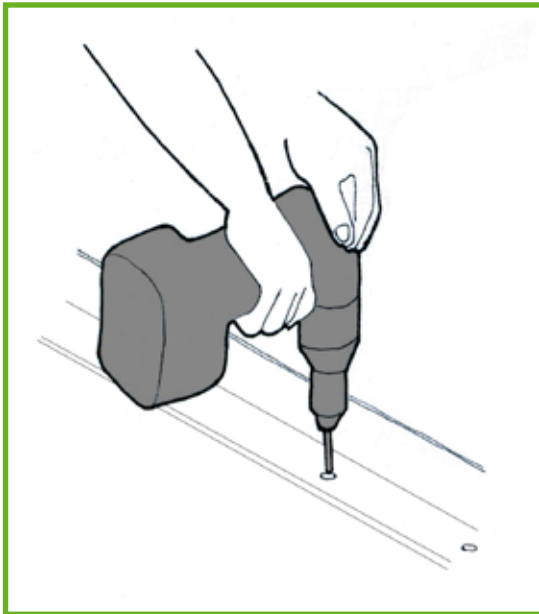

Wall connections

Upstands are always mechanically fastened. Water seeping behind the membrane is to be excluded by the use of flashing or parapet cover plates.

Installation according to the Flat Roof Guidelines

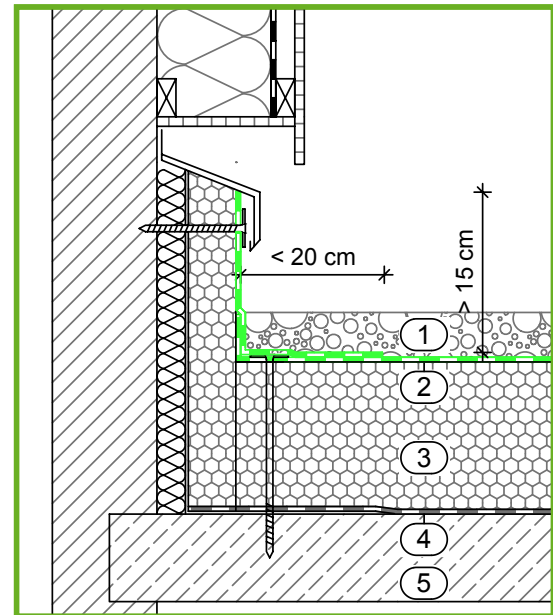

1) Gravel layer; 2) KÖSTER TPO Roofing Membrane ; 3) Insulation; 4) Vapor barrier

Parapet connections < 50 cm

The installation of a parapet connection is largely similar to that of a wall connection, only that the mechanical fasteners are placed at the top of the parapet. The parapet is to be properly covered with parapet cover plates, either made from folded metal sheets or a cap.

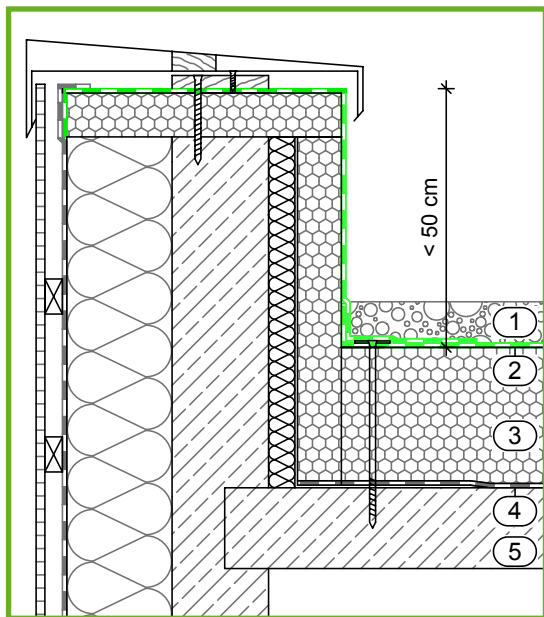

1) Gravel layer; 2) KÖSTER TPO Roofing Membrane ; 3) Insulation; 4) Vapor barrier; 5) Concrete substrate

Parapet connections >50 cm in one piece

When applying over a parapet >50 cm, the membranes are mechanically fastened onto the vertical wall. When installing a single layer the membranes are fastened with strips of TPO coated metal or individual fasteners, covered and welded over with KÖSTER TPO Membrane.

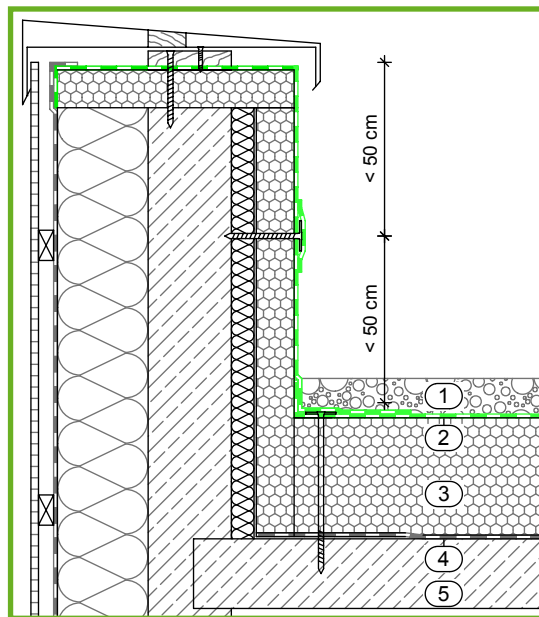

1) Gravel layer; 2) KÖSTER TPO Roofing Membrane ; 3) Insulation; 4) Vapor barrier; 5) Concrete substrate

Parapet connections >50 cm in two pieces

Parapet connection >50 cm, in two pieces.
Alternatively, the parapet connection can be
installed in two pieces. The advantage is that during
preparation the two membranes can be connected
with an automatic welding machine and then be
installed in the next step, (see page 32).

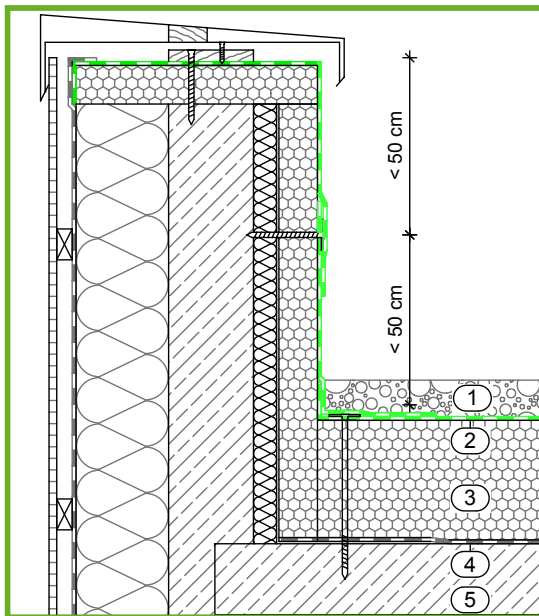

1) Gravel layer; 2) KÖSTER TPO Roofing Membrane ; 3) Insulation; 4) Vapor barrier; 5) Concrete substrate

Parapet connections >50 cm in two pieces

Installation of the two piece parapet waterproofing.
It saves time when the two membranes are
homogenously welded with an automatic welding
machine (1) and then installed (2 + 3). Manually
welding the vertical areas becomes unnecessary.

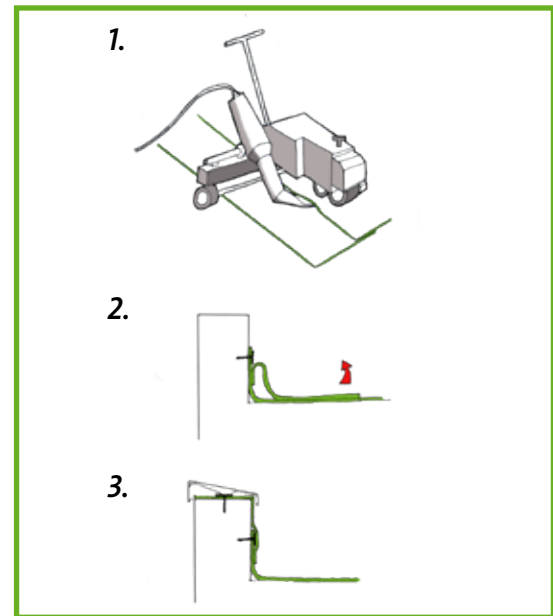

Tensioned connection

A tensioned connection is a visually appealing variant to waterproof the parapet. Here the KÖSTER TPO Roofing Membrane is mechanically fastened to the parapet and to the horizontal substrate. The vertical area is in tension between the two attached areas.

Maximal parapet height = 1.2 m

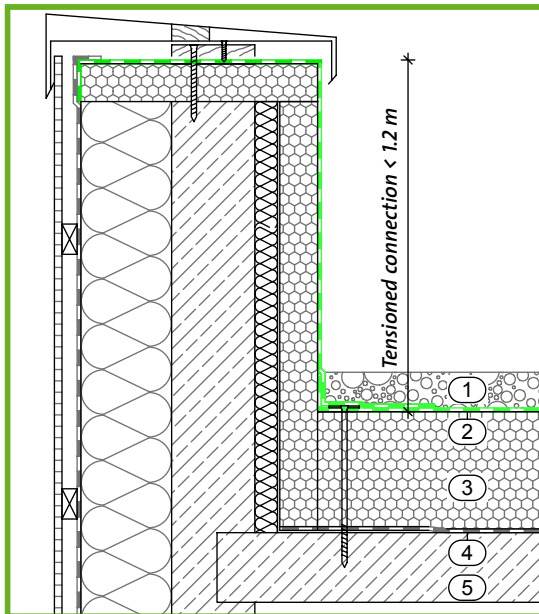

1) Gravel layer; 2) KÖSTER TPO Roofing Membrane ; 3) Insulation; 4) Vapor barrier; 5) Concrete substrate

Roof penetrations

Pipe penetrations are waterproofed with a flange, 50 cm x 50 cm and a sleeve. A hole is cut into the flange 4 cm smaller than the pipe diameter. The flange is pulled over the pipe. The sleeve is then welded around the pipe overlapping the flange.

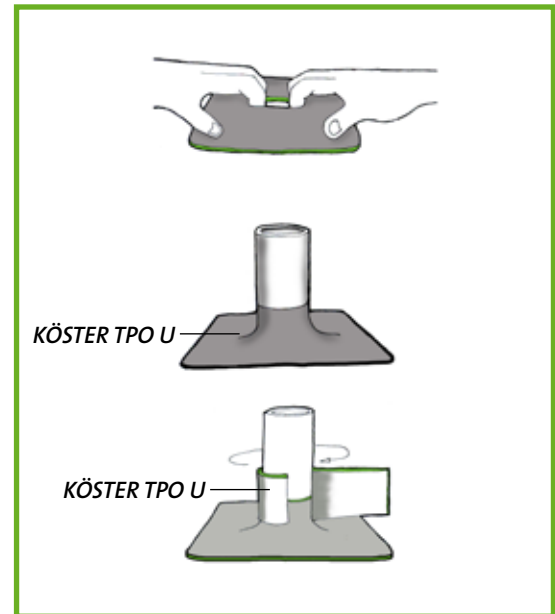

KÖSTER TPO U

KÖSTER TPO U

Roof penetrations

Prefabricated accessories are also available for roof and pipe penetrations. Connections and penetrations are always installed in two layers at the base. The waterproofing is brought up the roof penetration at least 15 cm. If the diameter of the penetration is > 25 cm, a stainless steel ring clamp needs to be additionally installed, (see graphic).

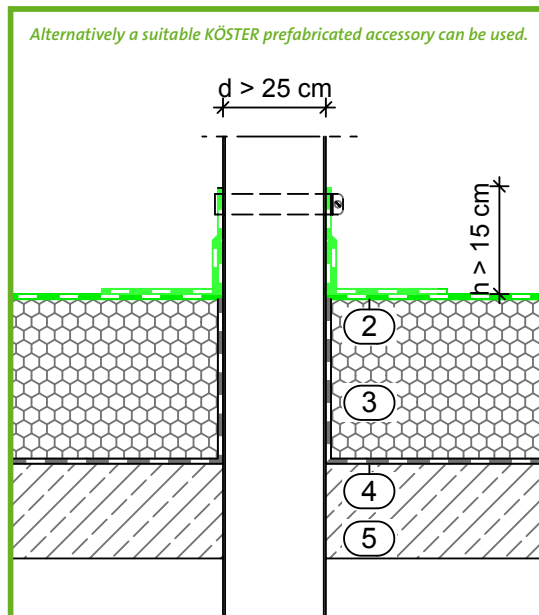

2) KÖSTER TPO Roofing Membrane ; 3) Insulation; 4) Vapor barrier; 5) Concrete substrate

Connection to skylight

TPO Membranes can be prepared as shown. Pre-creasing also eases manual welding. The corners are each reinforced with a corner patch. The corner patches are made from a piece of KÖSTER TPO U with a diameter of 8 cm.

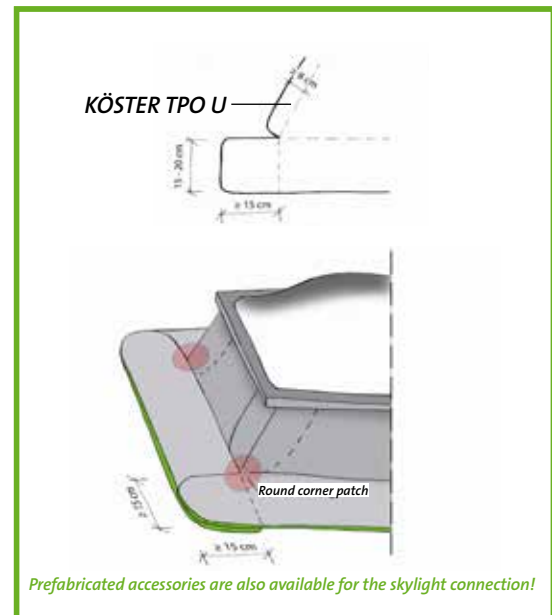

Connection to skylight

Upstanding waterproofing, as here in the case of a skylight, are mechanically fastened at their base. Attention must be paid that the upper connection of the TPO Membrane to the skylight is executed with a cover plate according to the Flat Roof Guidelines.

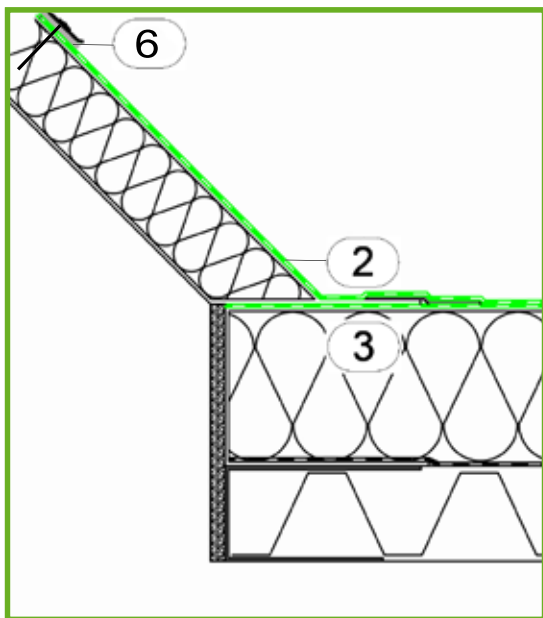

2) KÖSTER TPO Roofing Membrane ; 3) Insulation; 6) Cover plate

Joints

Expansion joints are dimensioned according to the structurally calculated building member movement. Expansion joints may not be closer than 50 cm to roof penetrations. The Flat Roof Guideline suggests planning joints at the highest point of the roof.

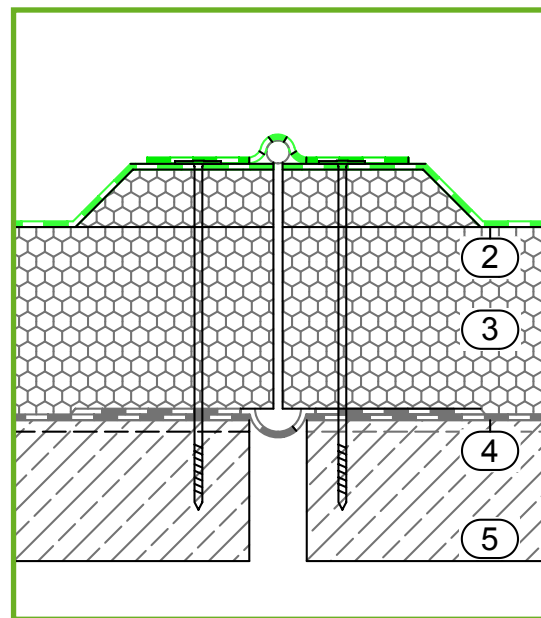

2) KÖSTER TPO Roofing Membrane ; 3) Insulation; 4) Vapor barrier; 5) Concrete substrate

Roof ridge installation

At ridges the TPO Membrane is applied over the ridge in two layers. This avoids eventual weak points in the waterproofing.

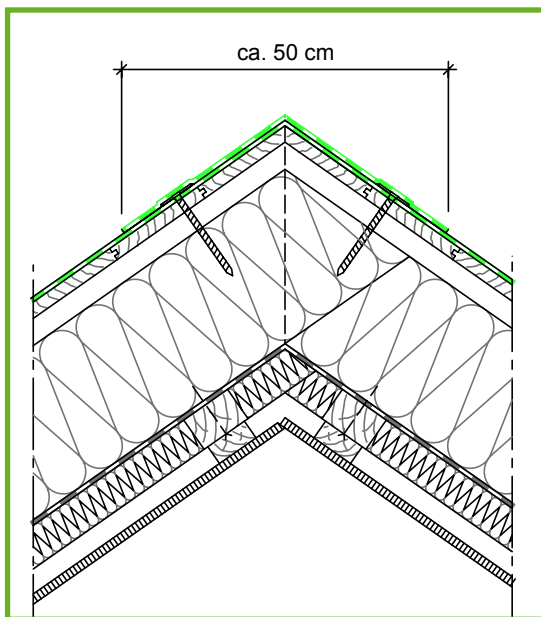

Connection to rain gutter

The waterproofing must be installed that no raised areas are created. Rainwater must be able to flow unrestricted.

The TPO Coated Metal can also be used as an apron flashing. The KÖSTER TPO Membranes can be directly welded to the coated metal.

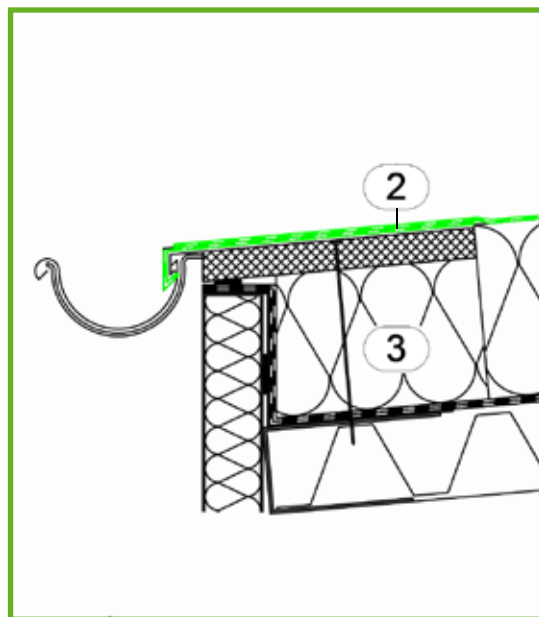

2) KÖSTER TPO Roofing Membrane; 3) Insulation

Connection to rain gutter

The same is valid for the eaves of a pitched roof.

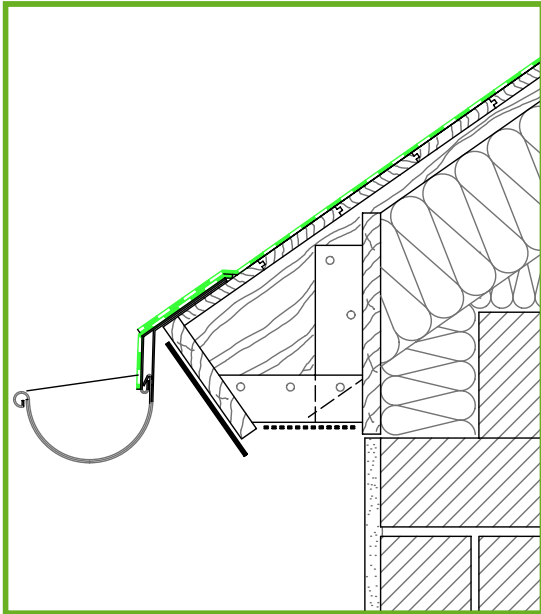

Roof drainage

KÖSTER suggests using prefabricated connection sleeves for connecting drainage systems in the roof area. Roof drains are recessed into the insulation to guarantee unrestricted water flow. According to the Flat Roof Guideline they must be positioned at least 30 cm from upstands.

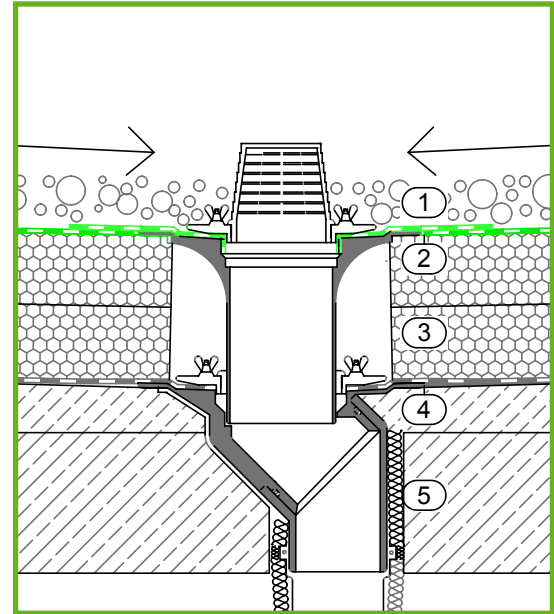

1) Gravel layer; 2) KÖSTER TPO Roofing Membrane ; 3) Insulation; 4) Vapor barrier; 5) Concrete substrate

Inside and outside corners

When waterproofing corners either prefabricated accessories or manually formed corners can be used. Before installing the corners the TPO membranes beneath them must be creased over the corners and welded.

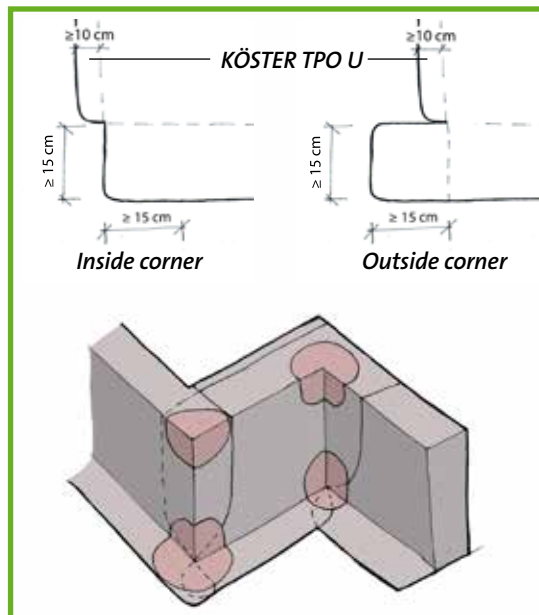

Pre-formed corners

Prefabricated accessories can be ordered from KÖSTER. They are faster and easier to use during installation. Alternatively inside and outside corners can be manually prepared, (see the following pages).

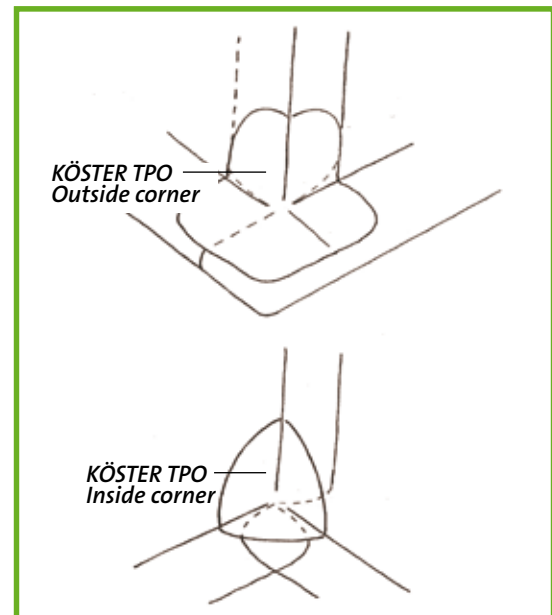

Manually prepared outside corners

Exterior corners can be prepared from roll material. For an exterior corner a diamond shaped piece of membrane is cut and the corners rounded.

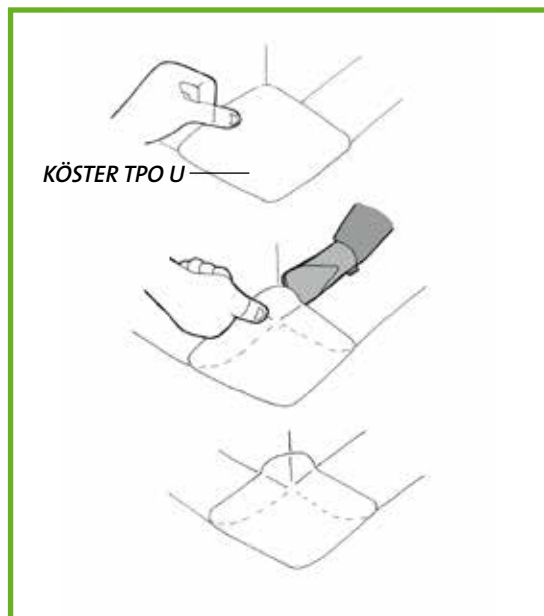

Manually prepared inside corners

Interior corners are manually prepared from a circular piece of KÖSTER TPO U with a diameter of 20 cm. A cross with right angles is drawn centered on the prepared circle (1). The circle is cut once to the center as shown (2).

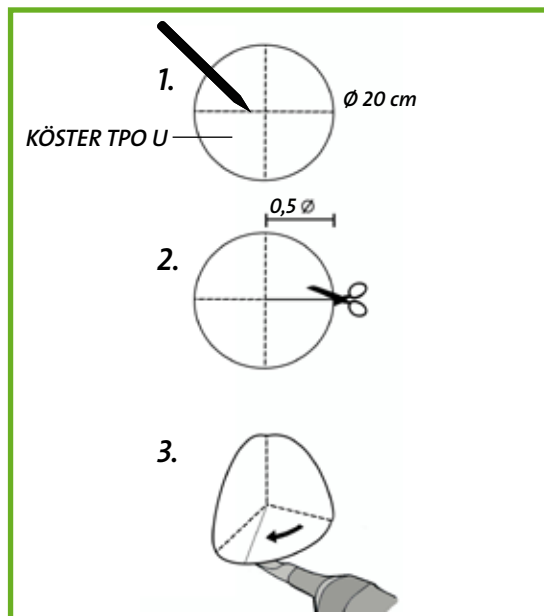

Manually prepared inside corners

The cut is pulled to the next quadrant of the cross to create an inside corner (3). The overlap is carefully welded (4). The inside corner is waterproofed and reinforced with a circular corner plug with a diameter of 5 cm (5). All seams must have an overlap of at least 2 cm.

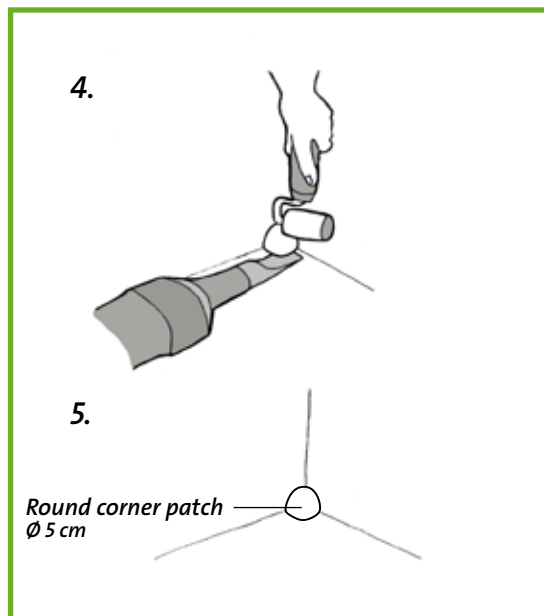

Separating layer

Decoupling layer

Generally no decoupling layer is required, as KÖSTER TPOs are free of plasticizers and will not react with the insulation.

Fire protection

Sometimes requires a decoupling layer, for this a glass fiber matting or synthetic matting is suitable.

Wood preservatives

May not negatively influence the roof construction or the roofing membrane.

Subject index

A

Affixing metal bands 13
Angle grinder 24
Automatic welding machine 10, 29, 41

B

Bituminous membranes 12

C

CE-Certification 5
Colored roofing 23
Colored roofing membranes 23
Connections and terminations 35
Connections to TPO coated sheet metal 33
Connection to rain gutter 49, 50
Connection to roof light dome 45
Cross joints 34

D

Decoupling layer 57
Dilation joints 14
DIN 4102 6
DIN 18338 6
DIN 18531 6
Drainage 14

E

Eg flat roofs 7

F

Fastening edges 36
Fastening plan 13
Fire behavior 6

Fire protection 57

Fire protection layer 12
Flammability 6
Flat Roof Guideline 47
Flat Roof Guideline 46
Flat Roof Guideline 13
Flat roofs 9
Flying sparks 5
Folding rule 10
Full surface adhesion 8

G

Green roof 7, 9

H

Hail impact 5
Hand held hot air welder 10
Hot air pistol 28

I

Industrial codes 6
Inside corner 55, 56

J

Joints 47

L

Loose installation 9

M

Manual welding 26, 28
Measuring 10
Mechanical fastening 7
Membrane end connections 31

N

Norms 6

O

Old membranes 24
Outside corner 54
Overlap 15
Overlaps 25
Ozone and radon 5

P

Parapet connections 38, 39, 40, 41
Parapet cover plates 37
Patina 24
Pitched roofs 7
Plasticizers 12
Polyurethane adhesive 23
Power generator 29
Pre-formed corners 53

Q

Quality 5

R

Roller 27
Roof drainage 51
Roof penetrations 43, 44
Roof ridge installation 48

S

Scissors 10
Seam edge 28
Separating layer 12, 57
Silicone roll 10
Skylight connection 45
Slope 14
Stainless steel ring 44
Supporting Construction 14

Surface 14

T

T connections 32
Tensioned connection 42
Test needle 30
Test welds 25, 30
Thermometer 10
Tools 10
TPO Coated Metal 49
TPO laminated metal 33, 35

W

Wall connections 37
Water ingress 35
Weathered membranes 24
Welding temperature 11, 25
Weld tester 10
Windproof 35
Wire brush 10
Wood preservatives 57



Service you can depend on

With our service and distribution network in many countries world-wide we can offer you professional advice and technical support immediately and on the spot. Your required waterproofing materials can be delivered promptly and will protect your property efficiently and lastingly.

For further information, please contact:



KÖSTER BAUCHEMIE AG | Dieselstraße 1-10 | D-26607 Aurich
Telefon: +49 (4941) 9709-0 | Fax: +49 (4941) 9709-40 | info@koester.eu | www.koester.eu